

Comfort and Precision in Industrial Applications



Comfort for Your Eyes—Precision for Your Work

Using a microscope for a long period of time can cause your eyes to become fatigued. We redesigned the SZ™ series of stereo zoom microscopes to reduce eyestrain and maximize user comfort.

Less fatigue and eyestrain leads to more precise and consistent results in your daily work.

All three models—the SZX7 microscope with its advanced Galilean optical system, the full-featured SZ61 microscope, and the versatile SZ51 microscope—are designed for user comfort and provide crisp 3D images with true color and high resolution.



SZ51



SZ61

CONTENTS

Features	1–12
• SZX7 Optical Performance	• SZ61/SZ51 Optical Performance
• Ergonomic Design	• Illumination System
• Digital Imaging and Recording System	• Mounting System and Accessories
Specifications	13–14
SZX7 System Diagram	15–16
SZ61/SZ51 System Diagram	17–18
Dimensions	Back Cover



SZX7



SZ61TR

SZX7: The ergonomic design combined with high image quality helps users to work for long periods of time without becoming fatigued.

SZ61: Excellent optical performance with a zoom ratio of 6.7:1.
Model variations: SZ61TR (with trinocular tube) and SZ61-60 (with a 60-degree observation tube inclination).

SZ51: Versatile, cost-efficient, and ideal in all line inspection applications.

Improved Ergonomics Means Improved Work Performance

Ergonomic improvements to our stereo microscopes enable natural posture for each user, improving comfort even when working for long periods of time.

Work in Comfort with Ergonomic Components

With the SZX7 microscope's ergonomic components, eyepiece height and angle can be easily adjusted to suit individual users. This reduces user fatigue, which leads to increased productivity and inspection quality.

7:1 Wide Zoom Ratio

With a magnification range of 8X–56X (using a 1X objective with a 10X eyepiece), the SZX7 microscope offers a maximum zoom ratio of 7:1. This zoom ratio enables most specimens to be observed at the appropriate magnifications.

Excellent Resolving Power

Superior quality objectives deliver accurate, high-resolution images that show specimens in minute detail.

Objectives that Suit Your Specimens and Applications

- Superior image flatness:

The DFPlan objective series accurately reproduces the original shape of the specimen.

- Long working distance (WD):

The objectives range from the SZX-ACH1X (90 mm WD) to the DFPL0.5X (198 mm WD). As a result, even specimen surfaces that are difficult to access can be easily observed.

- Ideal for high magnification:

The microscope delivers excellent image quality up to 336X by combining a 2X objective with 30X eyepieces. Also available is an excellent apochromatic objective, the DFPLAPO1.25X, with a higher zoom range of 1X through 7X.



Galilean optics feature two (right/left) independent and parallel zoom optical paths to produce the focal point with one objective. The system enables high optical performance as well as functional modularity.



ComfortView Eyepieces for Greater Comfort and Faster Work

ComfortView eyepieces feature pupil aberration control and appropriate positioning in the eye point for fast and comfortable observations.

Accurate Color Reproduction

The careful selection of lens surface coatings and glass materials for the entire optical system make it possible to observe and document specimens with accurate color reproducibility.

Sharp, Clear, and High-Contrast Images

The low, suppressed field curvature contributes to accurately reproducing the shape of the specimen.

A Wide Variety of Observation Tubes and Intermediate Tubes Enable Operators to Obtain the Right Image

Various types of tubes are available, and they can be freely combined to create the ideal system for any application.



Aperture diaphragm unit / SZX-AS



1. 45-degree binocular head / SZX-BI45 2. 30-degree trinocular head / SZX2-TR30
 3. Tilting trinocular head / SZX2-TTR 4. Ergonomic long tilting trinocular / SZX2-LTTR

Precise, Functional, and Compact—SZ61/SZ51 Microscopes

The SZ61/SZ51 microscopes incorporate the Greenough optical system and accomplish a range of practical observation and documentation functions in a compact design.

6.7:1 Wide Zoom Ratio

The SZ61 microscope's wide magnification range extends from 6.7X through 45X (using 10X eyepieces) with a zoom ratio of 6.7:1. The optical system enables fast, comfortable observations at the most appropriate magnification. The SZ51 microscopes has a magnification range of 8X through 40X (using 10X eyepieces) with a zoom ratio of 5:1.

Outstanding Depth of Focus and Flatness

The 10-degree angle convergence of the image forming path in the Greenough optical system delivers excellent image flatness with a deep depth of focus.

ComfortView Eyepieces for Greater Comfort and Faster Work

ComfortView eyepieces feature pupil aberration control and appropriate positioning in the eye point for fast and comfortable observations.

Accurate Color Reproduction

The glass material and surface coating on these objectives accurately reproduce the colors of specimens.

Sharp, Clear, and High-Contrast Images

The low, suppressed field curvature accurately reproduces the shape of your specimen.



The Greenough optical system has two zoom optical paths inclined at an inward angle. This enables a more compact microscope design while maintaining high performance.



Five Zoom Body Variations with High Performance

The SZ61 and SZ51 zoom bodies provide two different magnification ranges. They are available with an ergonomically designed 45-degree inclination tube for use on the standard stand. Models with a 60-degree inclination tube (SZ61-60/SZ51-60) are available for special applications where the zoom body has to be tilted for use with other equipment or mounted on a universal stand. For documentation purposes, we also offer the SZ61TR, which incorporates a trinocular tube for easy attachment of digital and video cameras.

Wide Choice of Auxiliary Objectives

A wide choice of auxiliary objectives enables observations at magnifications from 2X to 270X and a WD up to 350 mm.



Work Comfortably and Productively

We are committed to making work easy, comfortable, and productive through leading-edge ergonomic designs. That means applying advanced technological methods to improve operability, reducing factors that contribute to operator fatigue, and building in effective safety features like an electrostatic discharge (ESD) safe design.

Ergonomic Instruments Enable Natural Posture, Reduced Stress, and Increased Productivity

The ergonomic long tilting trinocular provides an optimized work position by bringing the microscope closer to the user, while the extendable eyepoint adjuster provides flexibility for users of different heights. The SZX series' ergonomic instruments reduce stress during observation by providing the most comfortable position for each user, increasing work efficiency.

Ergonomic Design Based on 3D CAD Analysis

The microscope body and stand feature precisely curved contours developed through careful 3D computer aided design (CAD) analysis. These key ergonomic features help reduce fatigue in periods of long observation.

Convenient Front-Access Operation

Improved ease of access to the most frequently used knobs and switches maximizes operator comfort and reduces back strain.

Precise Recall of Specific Magnification Settings via Integrated Click-Stop Mechanism (SZX7) or Zoom Knob Stopper (SZ61/SZ51)

Many inspection tasks require the use of the same zoom magnification setting to ensure consistent and comparable results. The integrated click-stop mechanism provides quick and easy access to this important function. The zoom knob stopper enables the user to accurately choose their desired magnification, and the setting in use is clearly displayed on the front control panel.

New Eyepiece Reduces Fatigue and Excludes Dust

This eyepiece features a pupillary aberration control mechanism so the image remains visible even if the operator's eyes move. This lessens operator fatigue in long-duration observations. The unique eyepiece mounting design excludes dust particles and keeps the eyepiece firmly in place, ensuring clear images and an ergonomic eyepiece position.

ESD Safety Design

All microscope bodies and accessories are ESD-safe and can discharge static electricity from 1000 V down to 100 V in less than 0.2 seconds, protecting the equipment and helping prevent sample damage.



Extendable eyepoint adjuster



LED transmitted / reflected light illumination stand



Zoom handle



Click-stop mechanism (SZX7)



Zoom knob stopper (SZ61/SZ51)



Eyepiece lock



Ground wire connection (back side)

Our Light Solutions Maximize Visibility in Different Tasks

We offer a range of light solutions precisely tuned to the stereo zoom microscope's optical system to maximize the visibility of minute characteristics.

Integrated LED Reflected/Transmitted Illumination Base

The universal reflected/transmitted illumination base brings together all the advantages of LED technology. It enables the simultaneous use of reflected and transmitted illumination and can alter their respective intensities continuously and separately through convenient dials on the base. The use of slim, ultra-bright LEDs successfully integrates transmitted illumination in a slim 25 mm thick base that facilitates easy specimen access and manipulation. The complete microscope, including the LED integrated base, is lightweight, compact, and easy to carry.

Universal Reflected Illumination Systems

Fiber optic illumination systems offer excellent illumination quality and flexibility. We offer a compact 6-watt LED light source (SZ2-CLS) and a 37-watt LED light source (LG-LSLED) for professional use. Homogeneous illumination can be achieved by a ring light. For special contrast effects on free-form 3D shapes, we offer a choice of single and double self-supporting spot illumination fiber guides and precisely adjustable flexible fiber guides.

*An equivalent model may be offered in some areas.

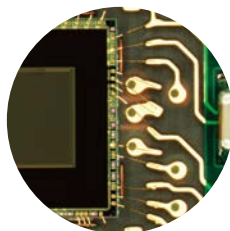

Homogeneous light

Transmitted Light Illumination Systems

For all transparent materials as well as for background illumination for the inspection of through holes, our illumination base enables you to select brightfield, darkfield, oblique, and polarized filter cartridge units (SZX2-ILLTS/SZX2-ILLTQ).

Also available is a brightfield/oblique illumination attachment (SZ2-ILA) that can accommodate various light sources.

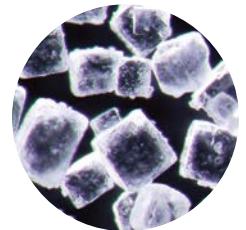

Darkfield light

Special Illumination Techniques

• Looking into holes

We offer effective coaxial illuminators for the SZX7 (SZX2-ILLC10) and the SZ61/SZ51 (SZ2-ILLC) microscopes, which direct the light through the microscope's optical axis onto the specimen.

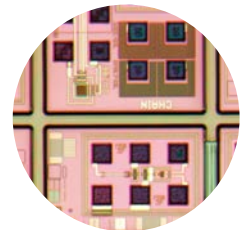

Coaxial light



Flexible angle of the LED light source



Homogeneous illumination fiber optic systems



Intelligent LED ring illumination



White LED illumination unit



Making Stress in Transparent Materials Visible

Also available are simple and advanced transmitted illumination stands with polarizing equipment (SZX2-AN, SZX-POL, and SZ-POL2) for the efficient evaluation of stress in transparent materials like plastic and glass. Their ease of use enables continuous, reliable production control of processes like injection molding.

The transmitted/reflected integrated LED illumination stand's slim body and easy operation enables quick observations in a comfortable posture.



Single illumination fiber optic systems



Transmitted and coaxial illumination with fiber optic systems



High-power fiber optic illumination system

Digital Imaging



SZX7 microscope with the DP74 digital camera system

DP74 High-Resolution Digital Camera

The high-resolution, 20.7-megapixel DP74 digital camera facilitates diverse research and development (R&D) applications. This versatile yet cost-effective camera features a Live HDR mode that optimizes contrast and brightness in individual regions and high-quality fluorescence imaging with powerful noise reduction and gain sensitivity functions.



SZX7 microscope with the DP23 digital camera system

DP28 and DP23 Compact Digital Cameras

When bench space is limited, the 8.9-megapixel DP28 camera and the 6.4-megapixel DP23 camera can be controlled without a PC. A dedicated control box provides smooth and intuitive operation via a touch screen monitor or a mouse.

Measurements and adding comments in an image are also available.

A Range of Accessories to Meet Your Needs

Easily Integrates with Other Equipment (Bonder and Prober Arms)

The SZX7, SZ61, and SZ51 microscopes are designed to be integrated into process equipment. We offer various bonder and prober arms for all common brands.



1. B & L style bonder arm / SZ2-STB1 2. Bonder arm / SZ2-STB2 3. Bonder arm / SZ2-STB3
4. Prober arm / SZ2-STP 5. Arm for SZX stand /SZ2-ST5



Stage Adapters for Efficient Inspections

For your convenience, a range of compatible stage adapters is available. This includes the cup stage SZH-SC, which gives the specimen a slant angle up to 30 degrees from level.



SZH-SC

Various Universal Stands

A variety of universal stands are available for the observation of large specimens. No matter how big the samples are or how much they vary in size, we have the right choice of stands to suit any requirements.



SZX7+SZ2-STU2



SZ61+SZ2-STU3

SZX7 specifications

Item	Specifications				
Zoom microscope body SZX-ZB7	Zoom drive: Horizontal knob system Click stop for each zoom magnification: ON-OFF switching possible Zoom ratio values: 7:1 (0.8X to 5.6X) Zoom magnification indication: 0.8, 1, 1.25, 1.6, 2, 2.5, 3.2, 4, 5, 5.6 Objective mounting: Screw mounting into thread Lead-free materials used				
Aperture iris diaphragm control: The AS unit (SZX-AS) is mountable					
Observation tube SZX-BI45 SZX2-TTR SZX2-TR30 SZX2-LTTR	SZX-BI45	SZX2-TTR	SZX2-TR30	SZX2-LTTR^{*1}	
	Binocular tube View inclination angle: 45° Lead-free materials used	Tilting binocular (trinocular) tube View tilting angle: 5° to 45° Light path selection: 2 steps (Binocular 100%, Video 50%/Binocular 50%)	Trinocular tube View inclination angle: 30° Light path selection: 2 steps (Binocular 100%, Video 50%/Binocular 50%)	Ergonomic Long Tilting Trinocular View tilting angle 5° to 45°, Light path selection: 2 steps (Binocular 100%, Video 50%/Binocular 50%)	
Interpupillary distance adjustable range	52 to 76 mm Eyepiece clamping knob provided			57 to 80 mm Eyepiece clamping knob provided	
Extendable Eyepoint adjuster	SZX2-EEPA: Height adjustment range: 30–150 mm (with a scale attached)				
Stand SZ2-ST SZ2-ILST	SZ2-ST	SZ2-ILST			
	Standard stand	LED reflected/transmitted illumination stand			
	Frame installation	Mounting diameter: 76 mm			
	Focusing adjustment	Knob rotation tension adjustment Focusing stroke: 120 mm			
	Stage plate	100 mm diameter dedicated glass plate is included			
Light source	Compact light guide illuminator (SZ2-CLS) mountable (option) Transmitted light illumination attachment (SZ2-ILA) mountable (option)	Transmitted illumination: LED Reflected illumination: LED Average LED life span: 6000 hrs. Input rating: 100–120 V/200–240 V~0.15/0.1 A, 50/60 Hz			
Objectives	Model		Working distance		
	DFPL0.5X-4 ^{*2} DFPL0.75X-4 DFPLAPO1X-4 SZX-ACH1X DFPLAPO1.25X SZX-ACH1.25X-2 DFPL1.5X-4 DFPL2X-4 All objectives: Lead-free materials		171 mm 116 mm 81 mm 90 mm 60 mm 68 mm 45.5 mm 33.5 mm		
Eyepieces	ComfortView WHSZ series All eyepieces: Lead-free materials				
Weight	Configuration 1	4360 g (9.6 lb)	5400 g (11.9 lb)	5200 g (11.5 lb)	5300 g (11.7 lb)
	Configuration 2	5160 g (11.4 lb)	6200 g (13.6 lb)	6000 g (13.2 lb)	6100 g (13.4 lb)

^{*1} SZX2-LTTR: intermediate magnification is 1.25X.

^{*2} The SZ2-ET auxiliary sleeve is required when the SZ2-ST/ SZ2-ILST is used.

Configuration 1: SZX-ZB7 + DFPLAPO1X-4 + individual observation tube + WHSZ10X-H (2) + SZ2-ST

Configuration 2: SZX-ZB7 + DFPLAPO1X-4 + individual observation tube + WHSZ10X-H (2) + SZ2-ILST

SZ61/SZ51 specifications

Item	Specifications				
Microscope body SZ61 SZ61-60 SZ61TR SZ51 SZ51-60	SZ61	SZ61-60	SZ61TR	SZ51	SZ51-60
	Magnification	0.67X to 4.5X			0.8X to 4X
	Zoom ratio	6.7:1			5:1
	Working distance	110 mm			
	Tube inclination angle	45°	60°	45°	60°
	Interpupillary distance adjustment	Left/right interlocked Adjustment range: 52 to 76 mm (using the WHSZ10X eyepieces)			
	Video camera adaptability	—	C-mount (0.5X built in)		—
	Zoom adjustment knob	Left/right single-shaft horizontal knob Interpupillary distance high/low magnification stopper incorporated.			
	Optical components	Lead-free materials used			
Auxiliary objective	Mounting by screwing into the thread at the bottom of frame (M48 thread X0.75)				
Eyepiece	ComfortView WHSZ series Lead-free materials used				
Stand SZ2-ST SZ2-ILST	SZ2-ST	SZ2-ILST			
	Standard stand	LED reflected/transmitted illumination stand			
	Frame installation	Mounting diameter: 76 mm			
	Focusing adjustment	Focusing stroke: 120 mm			
	Stage plate	SZ2-SPBW (Black and white for anti-ESD) SP-C (Clear glass plate) The dedicated glass plate in a 100 mm diameter is included			
Light source	Compact light guide illuminator (SZ2-CLS) mountable (option) Transmitted light illumination attachment (SZ2-ILA) mountable (option)		Transmitted illumination: LED Reflected illumination: LED Average LED life span: 6000 hrs. Input rating: 100–120 V/200–240 V ~0.15/0.1 A, 50/60 Hz		
Weight	Zoom body only	1300 g (2.9 lb)	1500 g (3.3 lb)	1300 g (2.9 lb)	
	Configuration 3	3520 g (7.7 lb)	3720 g (8.1 lb)	3520 g (7.7 lb)	

Configuration 3: Zoom body + WHSZ10X-H(2) + SZ2-ST

ComfortView WHSZ eyepiece

	FN	Diopter adjustment	Reticle	Focal magnification
WHSZ10X	22	—	N.A.	—
WHSZ20X	12.5	—	N.A.	—
WHSZ10X-H	22	-8+5	Yes*3	—
WHSZ15X-H	16	-8+5	Yes*3	—
WHSZ20X-H	12.5	-8+5	Yes*3	1.3X
WHSZ30X-H	7	-8+5	Yes*3	2X

*3 Applicable reticle size: 24 mm diameter, t1.5.

Auxiliary objective for SZ61/SZ51

	Working distance (mm)
110ALK0.3X	250-350
110ALK0.4X	180-250
110AL0.5X	200
110AL0.62X	160
110AL0.75X	130
110AL1.5X	61
110AL2X	38

SZX7 optical performance**4

Eyepiece	WHSZ10X-H WHSZ10X		WHSZ15X-H		WHSZ20X-H WHSZ20X		WHSZ30X-H	
	22		16		12.5		7	
Objective	Total magnification	Field of view (mm)	Total magnification	Field of view (mm)	Total magnification	Field of view (mm)	Total magnification	Field of view (mm)
0.5X	4X-28X	55-7.8	6X-42X	40.0-5.7	8X-56X	31.3-4.5	12X-84X	17.5-2.5
0.75X	6X-42X	36.7-5.2	9X-63X	26.7-3.8	12X-84X	20.8-3.0	18X-126X	11.7-1.7
1X	8X-56X	27.5-3.9	12X-84X	20.0-2.9	16X-112X	15.6-2.2	24X-168X	8.8-1.3
1.25X	10X-70X	22-3.1	15X-105X	16.0-2.3	20X-140X	12.5-1.8	30X-210X	7.0-1.0
1.5X	12X-84X	18.3-2.6	18X-126X	13.3-1.9	24X-168X	10.4-1.5	36X-252X	5.8-0.83
2X	16X-112X	13.8-1.9	24X-168X	10.0-1.4	32X-224X	7.8-1.1	48X-336X	4.4-0.63

** SZX2-LTTR: Intermediate magnification is 1.25X. SZX2-ILLC10: Intermediate magnification is 1.5X.

SZ61/SZ51 optical performance

Microscope body	Zoom magnification	WHSZ10X-H WHSZ10X		WHSZ15X-H		WHSZ20X-H WHSZ20X		WHSZ30X-H	
		FN 22		FN 16		FN 12.5		FN 7	
		Total magnification	Field of view (mm)	Total magnification	Field of view (mm)	Total magnification	Field of view (mm)	Total magnification	Field of view (mm)
SZ61	0.67X	6.7	32.8	10.1	23.9	13.4	18.7	20.1	10.4
	1X	10	22	15	16	20	12.5	30	7.0
	2X	20	11	30	8	40	6.3	60	3.5
	3X	30	7.3	45	5.3	60	4.2	90	2.3
	4.5X	45	4.9	67.5	3.6	90	2.8	135	1.6
SZ51	0.8X	8	27.5	12	20	16	15.6	24	8.8
	1X	10	22	15	16	20	12.5	30	7.0
	2X	20	11	30	8.0	40	6.3	60	3.5
	3X	30	7.3	45	5.3	60	4.2	90	2.3
	4X	40	5.5	60	4.0	80	3.1	120	1.8

No auxiliary objective is attached.

Light guide

Item		Specifications			
Model		SZ2-CLGR	SZ2-CLGDI	SZ2-CLGDF	SZ2-CLGSF
Tube type		Flexible tube	Interlocked tube	Flexible tube	Flexible tube
Total length		900 mm	580 mm	691 mm	663 mm
Fiber	Type (Material)	Multicomponent glass			
Bundle diameter	Input end	ø6 mm	ø5 mm	ø5 mm	ø4.5 mm
	Output end	ø2.4 × 6 mm	ø3.5 mm	ø6.4 mm	ø4.5 mm
Minimum bending radius		60 mm	60 mm	25 mm	25 mm

Compact light guide illuminator SZ2-CLS

Item	Specifications
Dimensions (W × D × H)	107 × 61 × 114 mm (4.2 × 2.4 × 4.5 in.)
Weight	Approx. 350 g (0.8 lb) (Main body)
Color temperature	Approx. 5,600 K
Light intensity adjustment	Continuous
LED life time	Approx. 50,000 hours (The light intensity is reduced by 70%)
Cooling	Convection
Ambient temperature	5 to 40 °C (41 to 104 °F)
Operating voltage	AC100-240 V (AC adapter)
Power consumption	Max. 6 W

LED ring illumination SZX2-ILR66

Item	Specifications
Features	4-part LED ring illumination 4-part independent ON/OFF available
Illumination	Operation modes : rotary, mirror ESD compatible, Clean class 1
Light source	17-step light intensity adjustable AC100-240 V
Others	SZX-LGR66/SZ-LGR66 adapters are required for SZX7/SZ61, respectively

SZX7 System Diagram

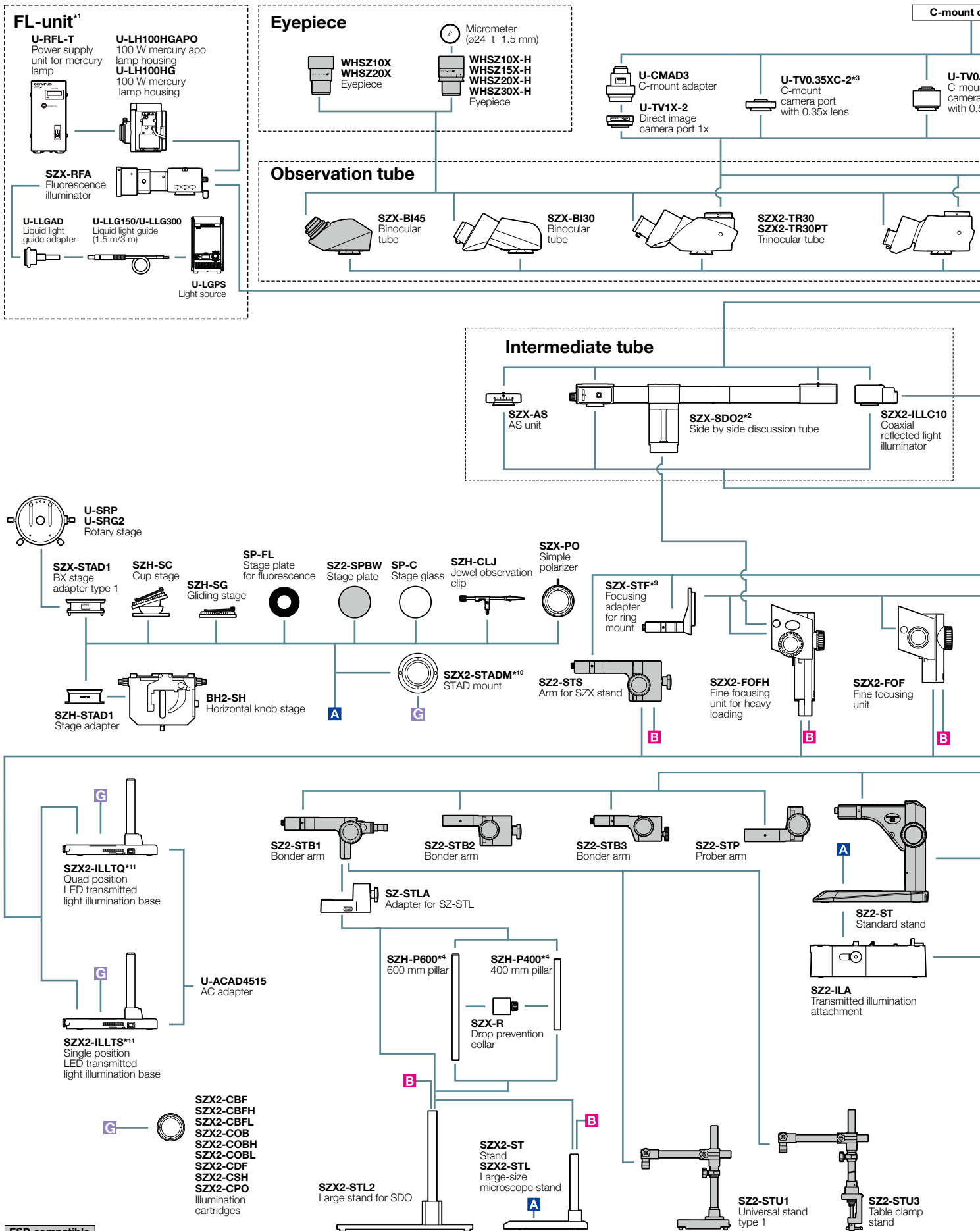

*1 Focusing unit (SZX2-FOF, SZX-FOFH or SZX-FO) and SZX-STF are required when mounting a fluorescent unit. *2 SZX2-FOFH and SZX2-STL2 are required when using SZX-SDO2.
 *3 Please contact your nearest Evident dealer for applicable cameras. *4 SZH-P400 and SZH-P600 can be attached to the transmitted light illuminators. *5 Equipped to SZX2-ILLC10.

camera

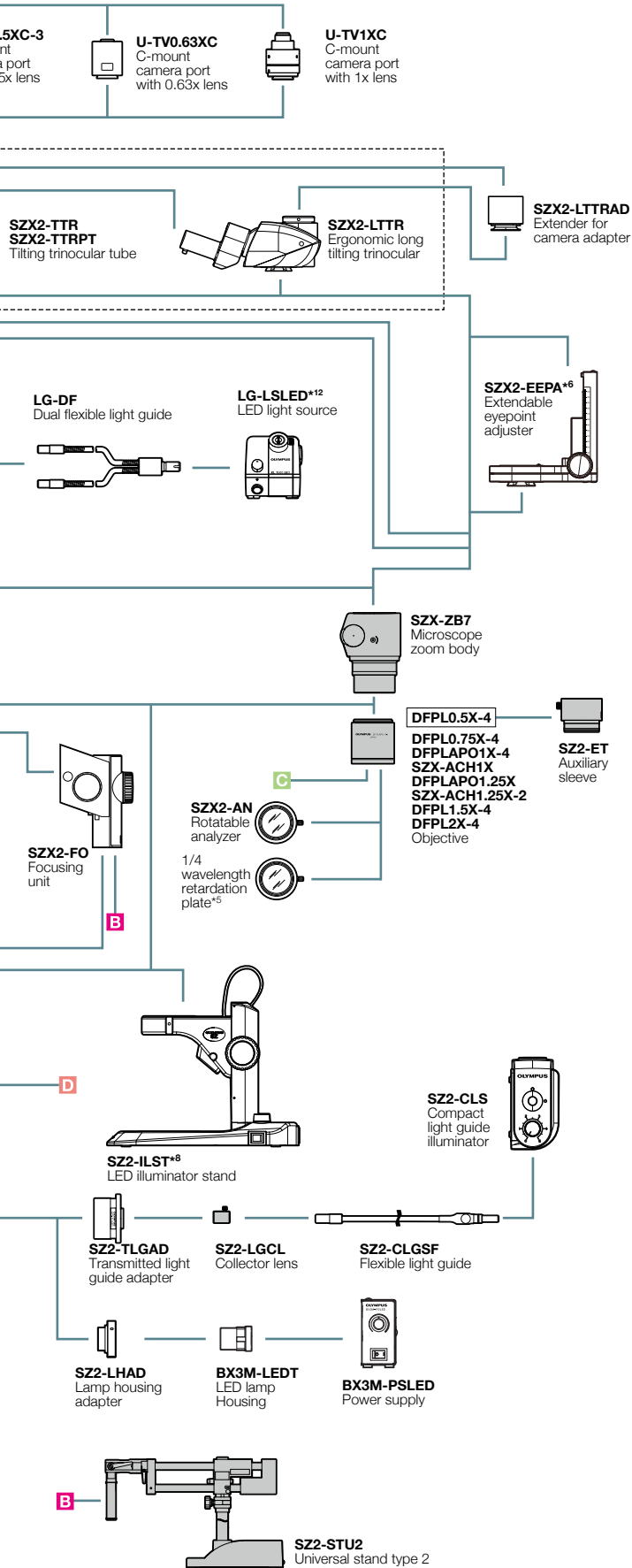

SZ2-CLS

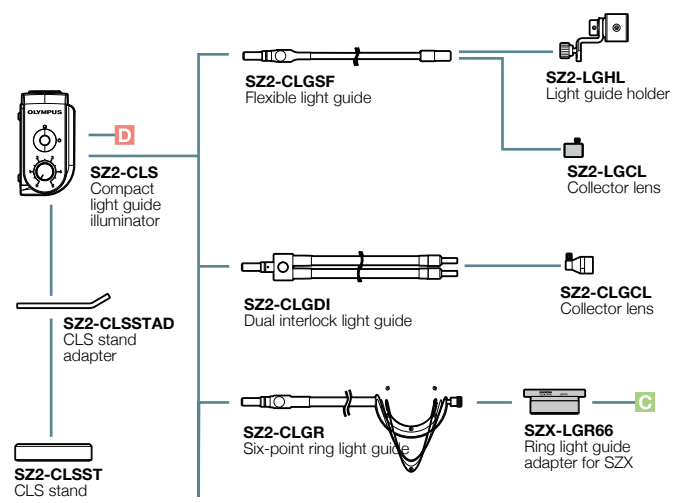

LG-LSLED

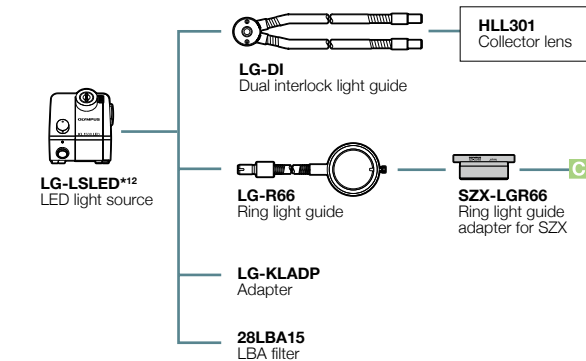

LED ring illumination

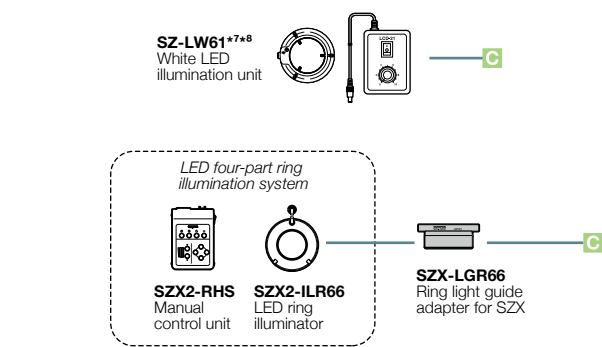

*6 Please contact your nearest Evident dealer for an applicable combination. *7 Not available in some areas. *8 SZ-LW61 cannot be combined with SZ2-ILST.
 *9 SZX-ACH1.25X and DFPLAPO1.5X-4 cannot be combined with SZX-STF. *10 SP-FL, SZ2-SPBW, SP-C, and SZX-PO cannot be combined.
 *11 SZ2-SPBW, SP-C, SZH-CLJ, SZX-PO cannot be combined with SZX2-ILTQ/ILLTS. *12 Different types may be offered in some areas.

SZ61/SZ51 System Diagram

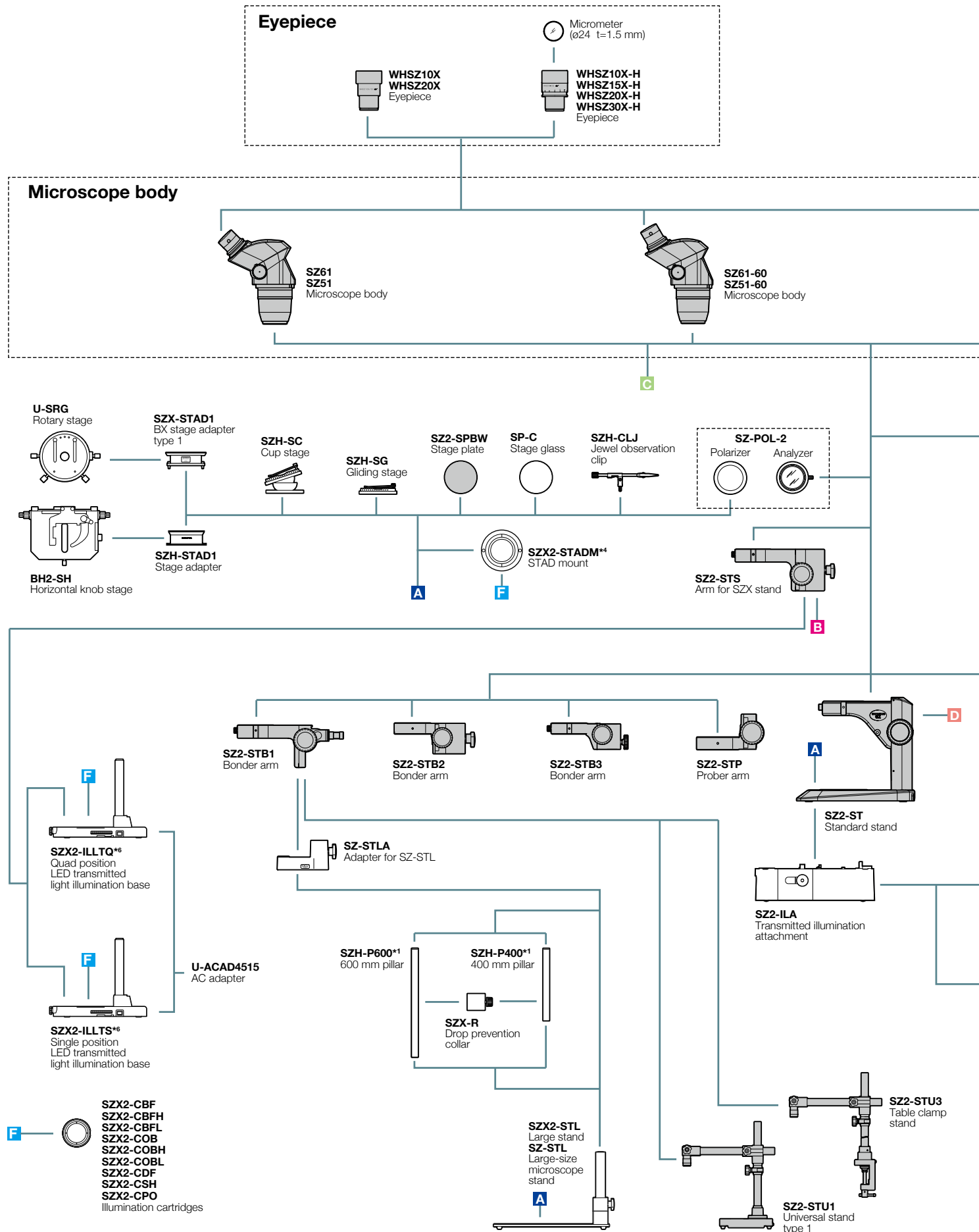

ESD compatible

*1 SZH-P400 and SZH-P600 can be attached to the transmitted light illuminators. *2 For information about a configurable illumination base or stand, contact your nearest Evident dealer. *3 Made to order. *4 SZX2-STADM cannot be combined with SZ2-SPBW and SP-C. *5 SZ2-SPBW, SP-C, SZH-CLJ, SZX-PO, SZ-POL-2 cannot be combined with SZX2-ILLTQ/ILLTS.

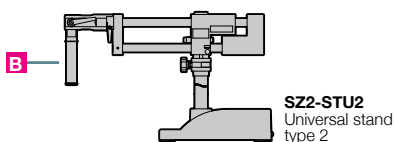
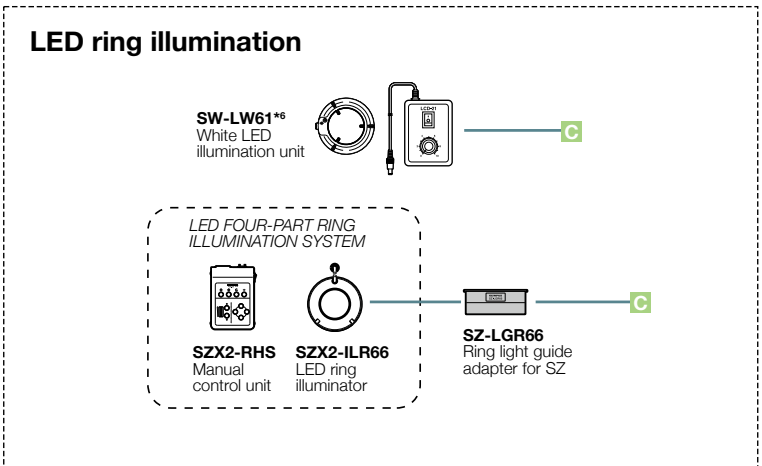
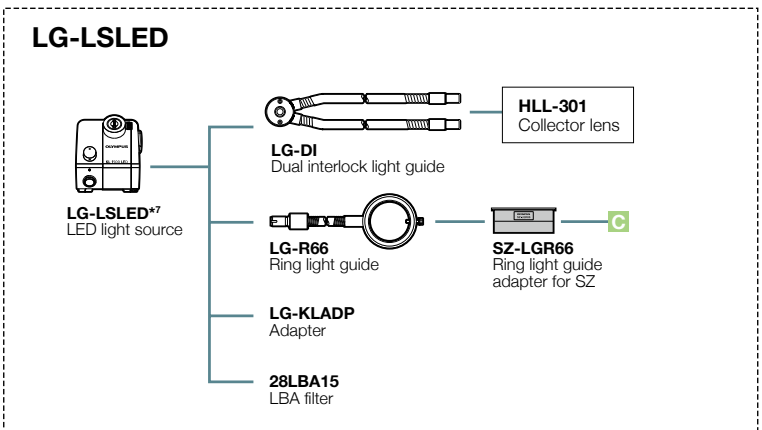
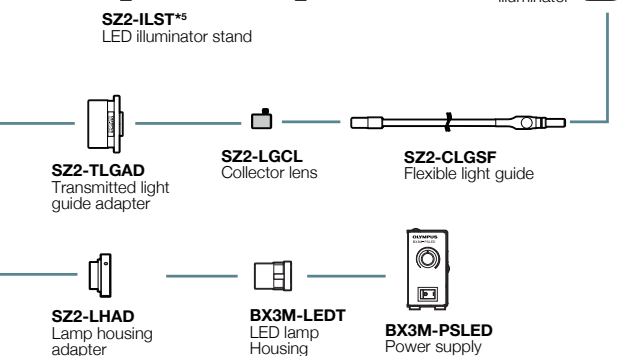
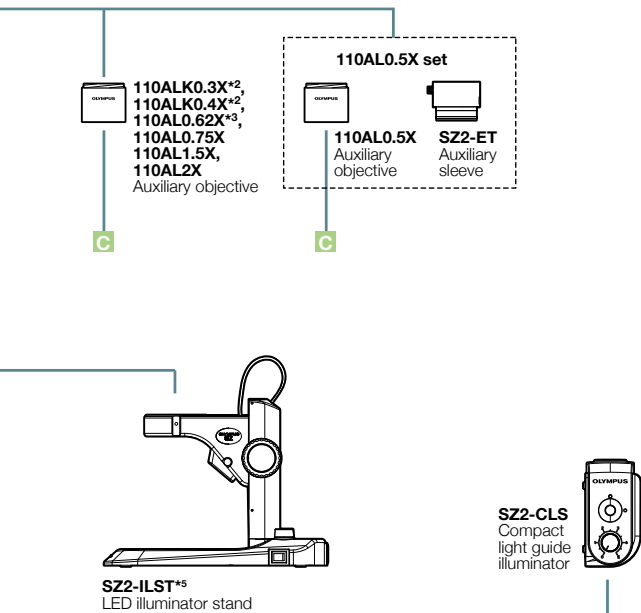
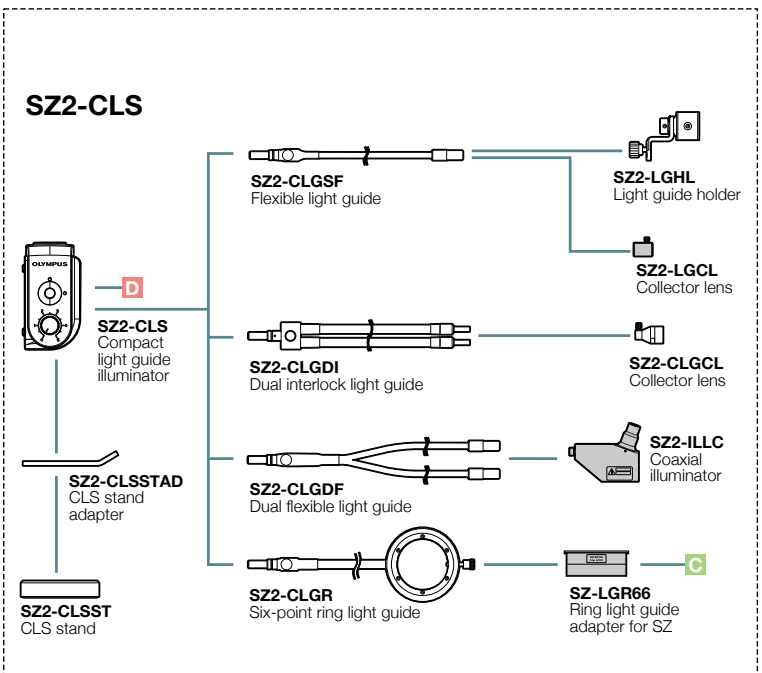
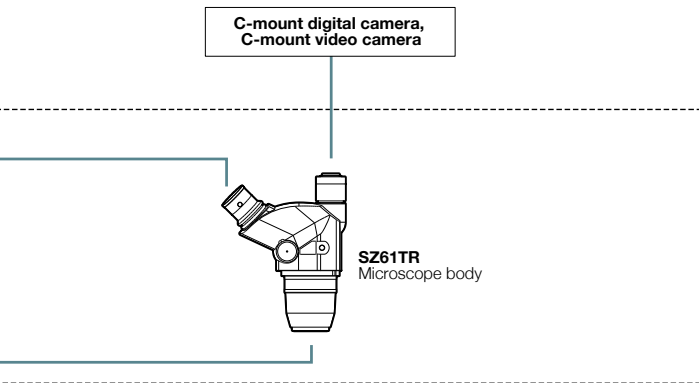

*6 SZ-LW61 cannot be combined with SZ2-ILST. *7 Different types may be offered in some areas.

SZX7 dimensions

(Unit : mm)

SZX7

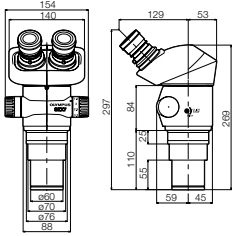

SZX7+SZ2-ST

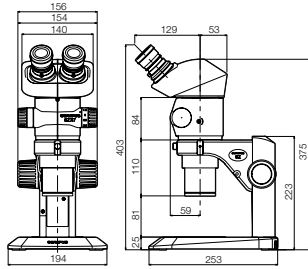

SZX7 (SZX2-TR30 configuration) +SZ2-ILST

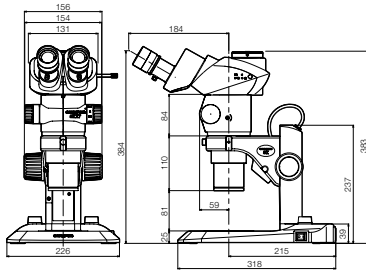

SZ61/SZ51 dimensions

(Unit : mm)

SZ61/SZ51

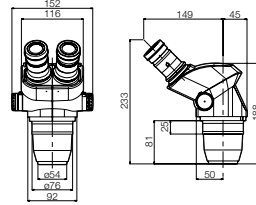

SZ61-60/SZ51-60

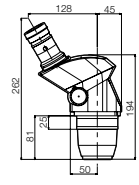

SZ61TR

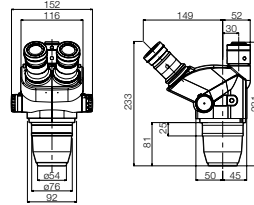

SZ61+SZ2-ST

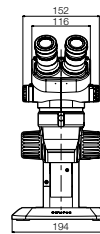

SZ51+SZ2-ST

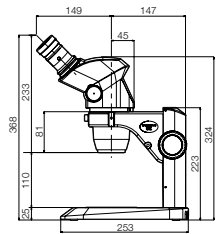

- EVIDENT CORPORATION is ISO14001 certified.
- EVIDENT CORPORATION is ISO9001 certified.
- Illumination devices for microscope have suggested lifetimes. Periodic inspections are required. Please visit our website for details.

- This product is designed for use in industrial environments for the EMC performance. Using it in a residential environment may affect other equipment in the environment.
- All company and product names are registered trademarks and/or trademarks of their respective owners.
- Images on the PC monitors are simulated.
- Specifications and appearances are subject to change without any notice or obligation on the part of the manufacturer.

EvidentScientific.com

EVIDENT

EVIDENT CORPORATION
Shinjuku Monolith, 2-3-1 Nishi-Shinjuku, Shinjuku-ku, Tokyo 163-0910, Japan

OLYMPUS